

PENTAX[®]

6x7



THE PENTAX 6x7—IN A CLASS OF ITS OWN

The Pentax 6x7 is a truly unique camera which plays an important role for the photographer. Although it's not a 35mm camera, it offers many of the convenient features inherent in the 35mm SLR design. Its versatile eye-level viewing, a fast electronic focal plane shutter, and rapid wind lever allow it to capture the action spontaneously. Its controls are positioned conveniently for handling ease. Its rugged camera body performs in the most extreme conditions, well-dampened mirror return assures smooth and steady shutter release, and minimizes camera vibration.

The 6x7 also offers a full array of the handy system features of the 35mm camera, including a full line-up of interchangeable lenses, interchangeable viewfinders and focusing screens, and a wide selection of close-up accessories for special uses such as macrophotography or astrophotography.

But, what makes the 6x7 really special is that its negative has *five times the image area of the 35mm negative*. Its superior 6x7 negative area gives "fine-grain" and excellent image definition on enlargement, plus greater flexibility in the darkroom for retouching, manipulations, and other creative applications.

The 6x7 also offers definite advantages over square format cameras. Its 35mm handling and rectangular negative size permits both vertical and horizontal shooting, and its 6x7 "ideal" negative size, while only slightly larger than the 6x6 square format, gives you 50% more usable negative area, because there is minimal cropping when enlarging on standard size papers. The 6x7 negative format avoids the problem of negative waste inherent in square format cameras.

Thus, the 6x7 is a truly unique camera. Although it's not designed for everyone, it's made for the photographer who needs a camera which has the ruggedness and handling ease for action shooting in the field, yet brings out the subtleties of studio work. With the superior 6x7 "ideal" negative format, you get top quality enlargements for whatever kind of work you are doing. In short, it's a camera for the photographer who needs the best of both worlds.



To enhance the photographic versatility of the Pentax 6x7, a wide array of precision photo accessories is available. The 6x7 Accessory System includes 18 bayonet-mount interchangeable lenses running from ultra-wide-angle to super telephoto and including a dynamic fisheye, a 135mm macro for close-up work, a shift-lens for perspective control and a 90mm leaf shutter lens for fast synchronization with flash. Each optic in the system features Pentax Super-Multi-Coating, which improves light transmission and reduces internal reflections for the brilliant color rendition that has made Pentax lenses the choice of photographers around the world. Special accessories for precision work include an accurate TTL metering pentaprism finder for full-aperture readings with automatic diaphragm lenses, optional viewfinders permitting use of the camera at waist and ground levels, on vertical copystands, and on low-height tripods. There's also an assortment of focusing screens for studio, architectural and other applications. The versatile 6x7 system covers virtually every photographic need.

THE IDEAL FORMAT NEGATIVE WITH THE VERSATILITY OF A 35mm CAMERA SYSTEM.

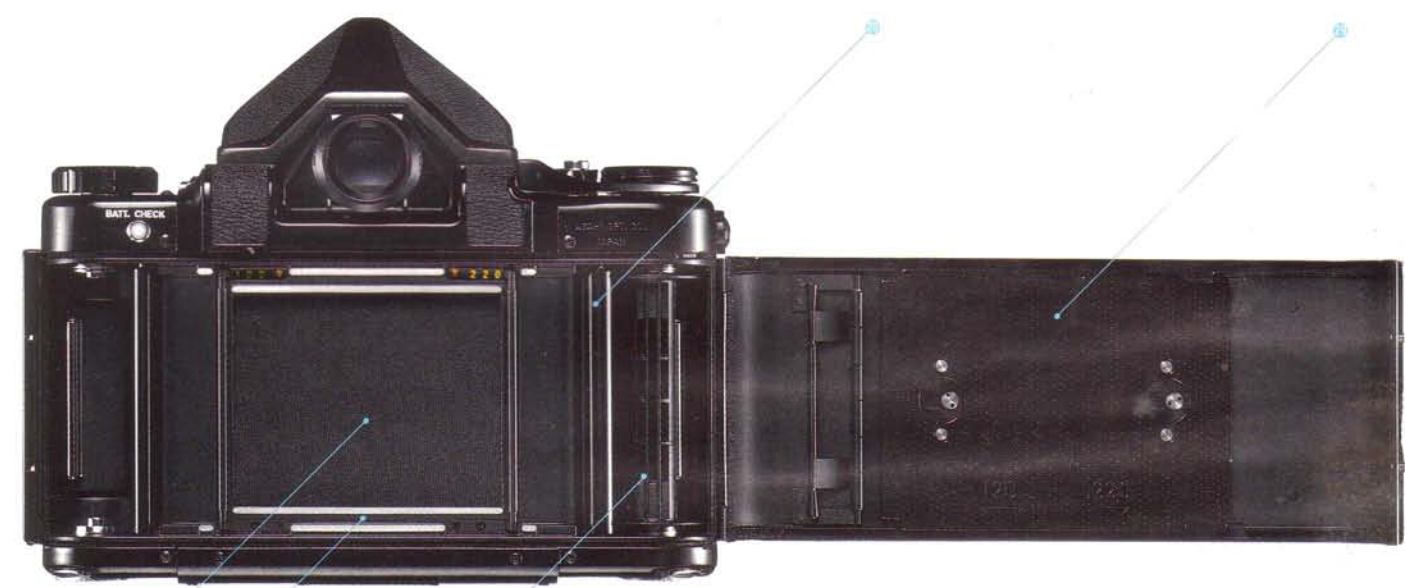

- 1 Safety device release button
- 2 Pentaprism
- 3 Neck strap lug
- 4 Battery check button
- 5 Eyepiece
- 6 120/220 film indicator
- 7 Rapid-wind lever
- 8 Exposure counter dial
- 9 Battery check lamp (Shutter speed index)
- 10 Push-button side locks
- 11 Shutter speed dial
- 12 Exposure counter
- 13 Shutter button
- 14 Shutter lock lever
- 15 Depth-of-field preview lever
- 16 Lens mount index
- 17 Depth-of-field scale
- 18 Distance scale
- 19 Filter/Hood/Cap index
- 20 Film spool retainer knobs
- 21 Tripod socket
- 22 Battery housing cover
- 23 Shutter curtain
- 24 Film guide rail
- 25 Spool
- 26 Counter roller
- 27 Film pressure plate (220/120 film positions)
- 28 Outer bayonet mount
- 29 Bayonet lock
- 30 FP/X flash terminal
- 31 Accessory alignment button
- 32 Exposure counter control dial
- 33 Mirror lock-up lever

● SPECIFICATIONS

Type:	6x7 ideal-format single-lens reflex.		
Film:	120 roll-film (10 exposures) 220 roll-film (20 exposures).		
Picture Size:	55mm x 70mm (2-1/4" x 2-3/4").		
Standard Lenses:	SMC Takumar 6x7 105mm f/2.4 and SMC Pentax 6x7 90mm f/2.8 lenses.		
Shutter:	Electronically-timed, double-curtain focal plane shutter; 1-1/1000 sec., plus "X" and "B".		
Power Source:	6V alkaline or silver oxide battery.		
Battery Check:	Push-button with indicator lamp.		
Viewfinder:	Detachable pentaprism finder, microprism focusing screen; 0.85 x magnification with standard lens; Shows 90% of picture area (100% with waist-level finders).		
Reflex Mirror:	Swing-up-and-back instant return mirror with lock-up provision.		
Film Transport:	Rapid-wind lever 180-degree angle with 10° stand off self-cocking shutter		
Exposure Counter:	Automatic reset exposure counter.		
Lens Mount:	Dual bayonet mounts: inner bayonet for 35mm — 300mm (plus 500mm and M* 800mm) lenses; outer bayonet for 400mm — 1000mm lenses (excluding 500mm and M* 800mm).		
Flash Synchronization:	FP and X terminals/electronic flash at 1/30 — 1 sec., B.		
Exposure Meter:	Accessory pentaprism with through-the-lens meter (TTL Pentaprism Finder) couples with shutter speed and aperture.		
Dimensions:	177mm (width) x 150mm (height) x 140mm (depth) (7.0"x5.9"x5.5"), with 90mm lens and pentaprism.		
Weight:	Body:	1,290 grams (45.5 ozs.)	90mm f/2.8 lens: 485 grams (17.1 ozs.)
	Pentaprism housing:	460 grams (16.2 ozs.)	

PRECISION MECHANICAL FEATURES FOR HIGH QUALITY RESULTS AND VERSATILE OPERATION

Accurate Electronic Shutter

The Pentax 6x7 is equipped with a focal plane shutter, a feature which distinguishes it from its square format competitors. Not only is the shutter electronically timed for matchless accuracy, but it enables a shutter speed range from 1 second up to a very fast 1/1000 of a second, a speed uncommon in medium and large format cameras. The shutter is powered by a 6V battery and a battery lamp on top of the camera lets you check its performance. The shutter speed dial, positioned on the left side of the camera, is easily reached and allows you to operate the shutter button and film advance while holding the camera at eye-level.



Film Type Selector

The Pentax 6x7 accepts 120 roll-film (10 exposures) or 220 roll-film (20 exposures). Simply shift the film pressure plate to the right for 220 roll-film, or shift the film pressure plate to the left for 120 roll-film. After you have performed this simple adjustment, you will notice that the numbers 120 or 220 appear in a window on the back cover to remind you of the type of roll-film you are using. Then proceed to set the film-type dial to the setting which is appropriate for the type of film you are using.

35mm SLR Type Rapid-Wind Lever

Advancing the film in the Pentax 6x7 is as simple as using a 35mm SLR. A 180 degree stroke of the rapid-wind lever advances the film and cocks the shutter. Quickly, you are ready for the next picture, making sequence shots a snap. When you advance the film, the exposure counter also advances, indicating a maximum of 10 exposures for 120 film, or 20 exposures for 220 film. The shutter release button is positioned next to the rapid-wind lever and is easily reached with the index finger. A lock lever prevents accidental exposures and also permits time exposures when using the B setting of the shutter speed dial.

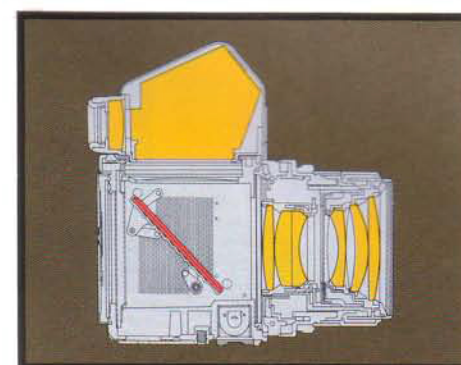

Large, Swing-Back Mirror

The 6x7 is equipped with a swing-back mirror which returns instantly after the exposure to insure uninterrupted viewing. A damping device in the walls of the mirror chamber reduces mirror shock, while crank rotation assures smooth operation with minimal vibration. Four times larger than the mirror of a 35mm SLR, it gives 100% image area when used with the waist-level finders. Also, for critical work, such as macrophotography and ultra-telephotography, the mirror can be locked up to eliminate shock entirely.

Stable Film Transport Method

For large formats such as 6x7, sharpness of the image on the negative depends heavily on both the film transport method and adjustment of the film pressure plate. For this reason, the Pentax 6x7 film take-up system features direct winding onto the take-up spool which follows the film's natural curve. A counter roller spool, film guard rails, and the film pressure plate coordinate together to apply the exact pressure needed to hold the film gently, but firmly, in place and maintain film flatness for edge-to-edge sharpness. The two factors, direct wind and pressure plate adjustment, assure the flatness of the film plane for optimum sharpness.

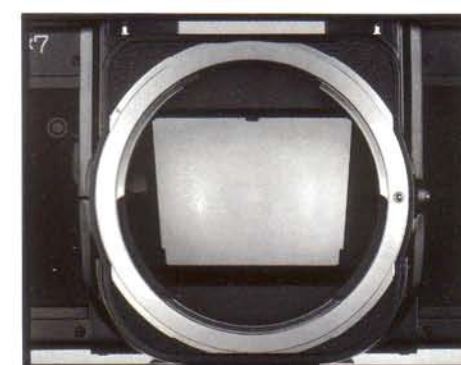
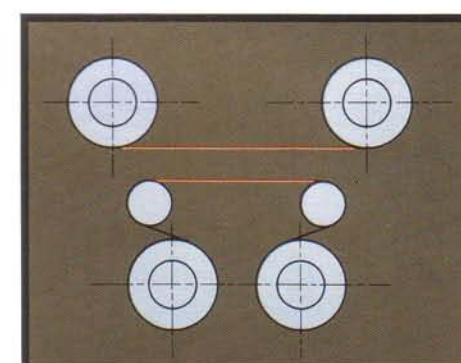

Quick Lens Changes

The 6x7 features a dual inner/outer bayonet mount system which permits quick lens changes no matter which lens you are using. The 3-prong inner bayonet mount accepts lenses from 35mm to 300mm, plus the 500mm and M* 800mm lenses, while the four-prong outer bayonet is for all telephotos from 400mm to 1000mm excluding the 500mm and M* 800mm lenses. Each lens from fish-eye to 500mm and M* 800mm telephoto (except the shift lens and 400mm lens) features fully automatic diaphragm, and a single flick of the right forefinger on the Auto/Manual lever stops the lens down to shooting aperture to preview the depth-of-field.

INTERCHANGEABLE FINDERS AND FOCUSING SCREENS FOR A WIDE RANGE OF APPLICATIONS

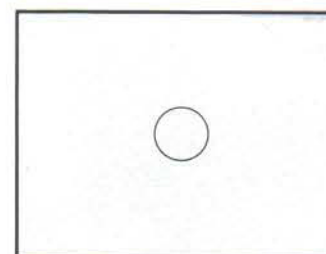
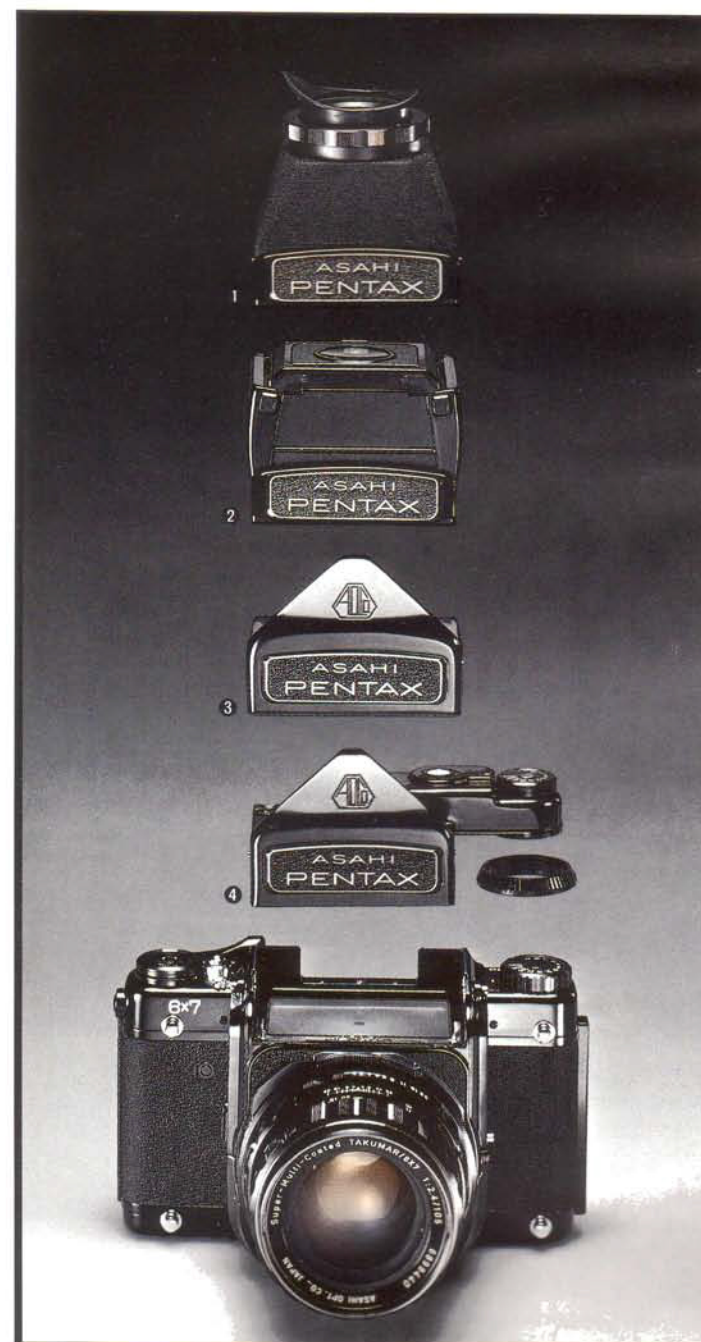

• All-Matte Field

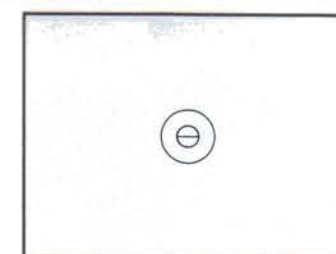

• Matte Field + Central Split-Image Spot

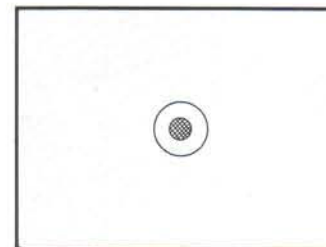

• Matte Field + Central Microprism Spot

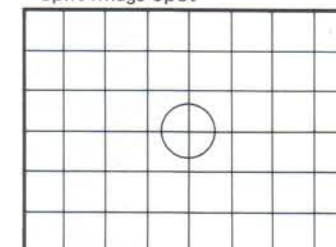

• Matte + Crosslines

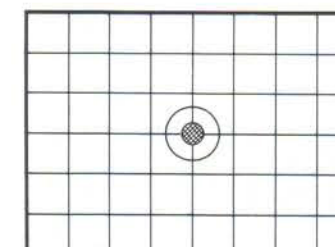

• Matte + Crosslines + Central Microprism Spot



A sophisticated system must have interchangeable finders for special applications. There are four kinds of finders available including waist-level finders and pentaprism finders.

1 **Rigid Magnifying Hood:** This deluxe waist-level type finder completely shields the focusing screen from ambient light for crisp, clear viewing. The 1.3X magnifier can be adjusted to viewer's eyesight for maximum viewing comfort. The entire focusing screen is visible for a 100% view of the negative area.

2 **Folding Focusing Hood:** This waist-level, compact folding finder has a built-in 1.6X magnifier and is ideal for macrophotography and ultra-telephotography. The folding focusing hood simplifies low-angle shooting; the magnifier folds out of the way to show 100% of the negative area.

3 **Pentaprism Finder:** This is the standard pentaprism finder unit. Extremely compact, with a large, bright viewing area, it weighs only 460 grams and detaches instantly from the camera body and shows 90% of the negative area.

4 **TTL Pentaprism Finder:** The Through-The-Lens metering Pentaprism Finder attaches to the camera in the same manner as the other viewing units and automatically couples to the shutter speed dial and aperture for "zero-method" exposure control. The through-the-lens meter reads an average of the total light entering the camera. All readings are made with the lens wide open, as the meter is mechanically cross-coupled to the camera.

Interchangeable Focusing Screens:

In addition to the microprism screen already installed in the 6x7, four other focusing screens are available and can easily be installed at your nearest Pentax service center or distributors.

• **All Matte Field** — For general work such as portraits and action photography.

• **Matte + Central Microprism Spot** — This screen comes as standard with the 6x7. For general applications focus with the central microprism spot or surrounding matte field.

• **Matte + Central Split-Image Spot** — A central microprism replaces the split-image center spot, making an excellent aid for critical focusing and for eyeglass wearers.

• **Matte + Crossline Field** — The crossline screen provides accurate measurement both vertically and horizontally. For architectural and indoor photography.

• **Matte + Crossline Field + Central Microprism Spot** — The central microprism and crosslines provide pinpoint focusing and exact alignment.

SUPERIOR QUALITY FROM LARGE SIZE FILM. THE IDEALLY PROPORTIONED FORMAT.

The Pentax 6x7 handles like a 35mm camera with its rapid-wind lever and focal plane shutter. A major difference, however, is its film size: 55mmx70mm — nearly four times as large as 35mm film. This means superior image quality and resolution. The image is not only sharper and filled with more detail, but film grain is far less visible, which makes a big difference for enlargements.



• This illustration compares the image quality of a 6x7 and a 35mm enlargement. The top photo was cropped from 6x7 film and the bottom photo was taken on 35mm film. The 6x7 enlargement is not only sharper, but has much less grain as the enlargement readily shows.

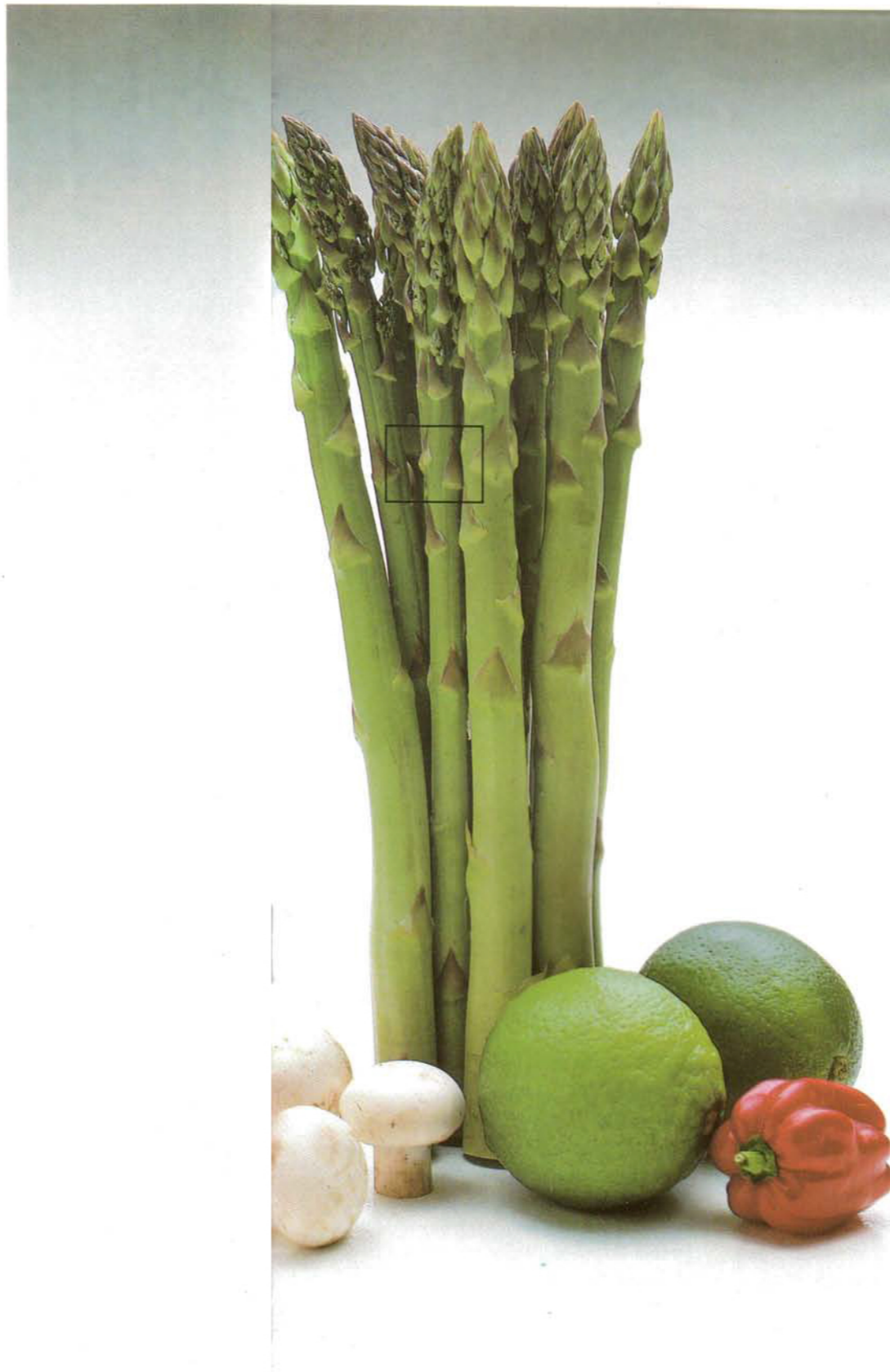

6x7 film has an area of 3,850 sq. mm, and needs to be enlarged 3.2 times to make an 8x10 print. Little cropping is required. 6x6 film, in comparison, has an effective area of only 2,508 sq. mm and needs to be enlarged a full four times to make an 8x10 print. For enlargement, although the 6x7 has only 21% more actual film area than the 6x6, it offers 50% more usable picture area than the 6x6 "square".

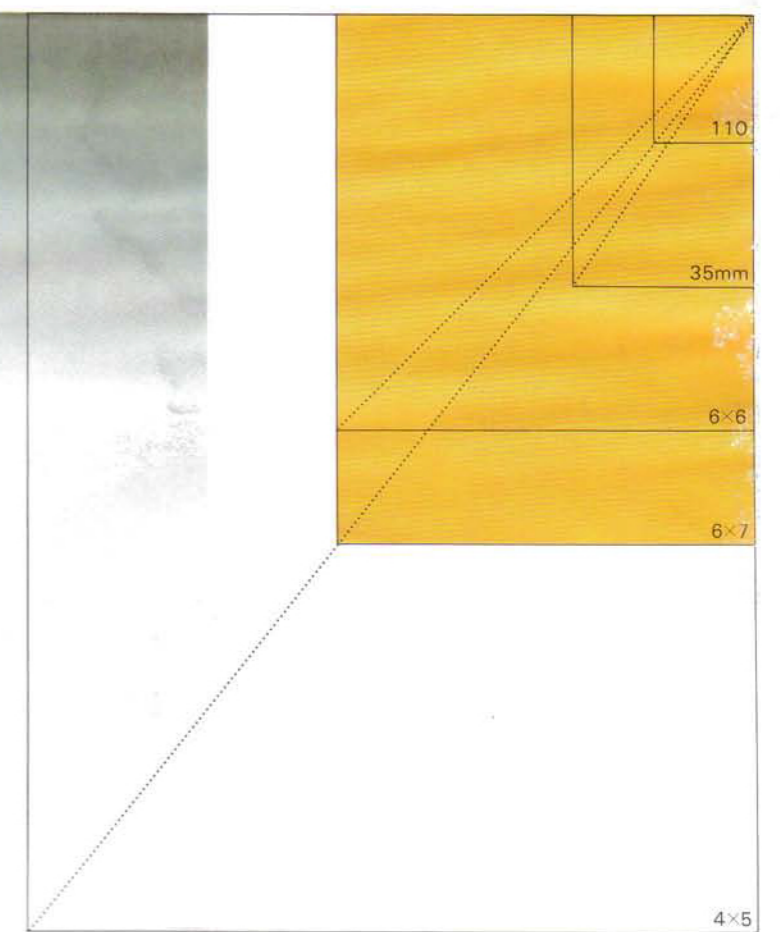

• The chart shows the advantage of 6x7 film in proportion to the 6x6. Its rectangular area closely matches standard print formats such as 8x10, 14x17, etc., and requires far less cropping. The light blue area shows the additional amount of cropping needed with a 6x6 to make a standard enlargement compared to the dark purple area for the 6x7.

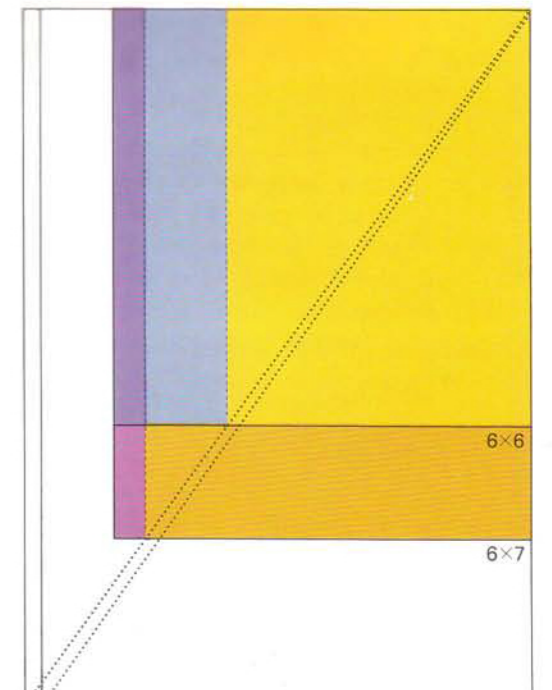

CONTRAST, RESOLUTION, COLOR REPRODUCTION... INTERCHANGEABLE LENSES FOR THE 6x7 PROVIDE BEAUTIFULLY-BALANCED PERFORMANCE

A major advantage of the Pentax 6x7 is the quality of its lenses. SMC Pentax and Takumar Lenses have earned an international reputation among photographers for their precision quality, sharp contrast and resolution, with excellent light balance for color reproduction. All eighteen 6x7 lenses feature Super-Multi-Coating, Pentax's unique 7-layer lens coating process which

greatly reduces flare and ghost images for unsurpassed image quality. One reason for this is Asahi Optical's obsession with image quality. The 6x7 gives you a wider choice of lenses than any other medium format camera, from 35mm fisheye to 1000mm telephoto, from a 90mm leaf-shutter lens for multi-exposures and high-speed flash synch to a 75mm shift lens for perspective controls.



Experience and Computer Generation Optics are Perfectly Combined

Today's camera lenses are extremely complex. But at Pentax, painstaking efforts are taken to assure quality, and the potential for making quality lenses has become infinity easier through the use of computers.

Today's computer-generation Pentax optics are repeatedly tested and matched for factors such as image tone, color, and focusing balance. Moreover, lens coating is measured and its effectiveness recorded with unprecedented accuracy through the use of computers.

Essential corrections are made much more quickly and easily. In addition, factors such as quality control, mass productivity are all computer-programmed, to produce the finest product with the greatest efficiency.

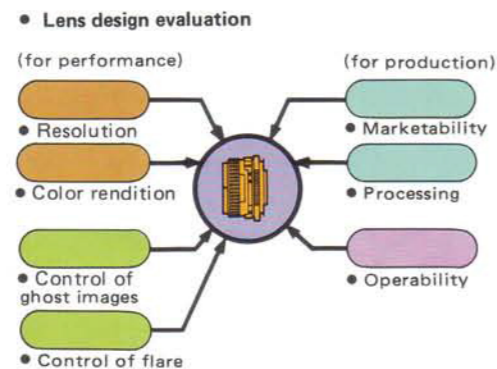

High Quality Lenses with Minimum Flare and Ghost Images

Painstaking care is taken in the production of a 6x7 lens to eliminate optical disturbances such as lens flare and ghost images. Each 6x7 lens has been treated by Pentax Super-Multi-Coating. This highly effective lens coating technique was developed by Pentax solely for the purpose of improving optical quality.

SMC treated Pentax lenses transmit a remarkable 99.8% of the incident light to produce extra bright images, offer higher resolution, maintain better contrast, and provide superb color balance and saturation.



• Photo with super-multi-coated lens.



• Photo with single-coated lens.

EIGHTEEN OPTICAL WONDERS FROM 35mm FISHEYE TO 1000mm TELEPHOTO



**SMC FISH-EYE TAKUMAR 6/7
35mm f/4.5**



**SMC TAKUMAR 6/7
75mm f/4.5**



**SMC TAKUMAR 6/7
105mm f/2.4**



**SMC TAKUMAR 6/7
200mm f/4**



**SMC TAKUMAR 6/7
300mm f/4**



**SMC TAKUMAR 6/7
400mm f/4**



**SMC PENTAX 6/7
45mm f/4**



**SMC TAKUMAR 6/7
90mm f/2.8**



**SMC PENTAX 6/7
165mm f/2.8**



**SMC PENTAX SHIFT 6/7
75mm f/4.5**



**SMC PENTAX 6/7
500mm f/5.6**



**SMC PENTAX 6/7
55mm f/4**



**SMC PENTAX 6/7
90mm f/2.8**



**SMC MACRO TAKUMAR 6/7
135mm f/4**



REAR CONVERTER T6-2X

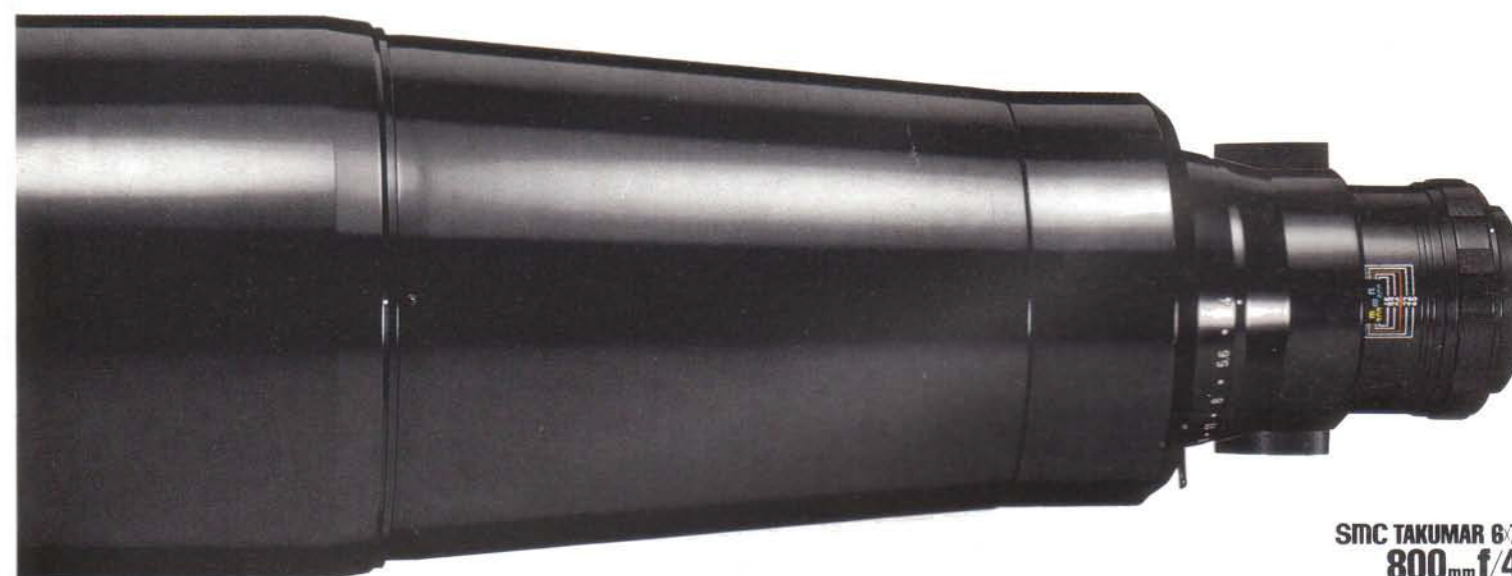

**SMC TAKUMAR 6/7
800mm f/4**

Lenses with Built-in Lens-hoods :
 SMC Pentax 6x7 165mm f/2.8
 SMC Takumar 6x7 200mm f/4
 SMC Takumar 6x7 300mm f/4
 SMC Takumar 6x7 400mm f/4
 SMC Takumar 6x7 500mm f/5.6
 SMC Takumar 6x7 600mm f/4
 SMC Takumar 6x7 800mm f/4
 SMC Reflex-Takumar 6x7 1000mm f/8
 SMC Pentax-M* 67 800mm f/6.7 ED(IF)



**SMC TAKUMAR 6/7
600mm f/4**

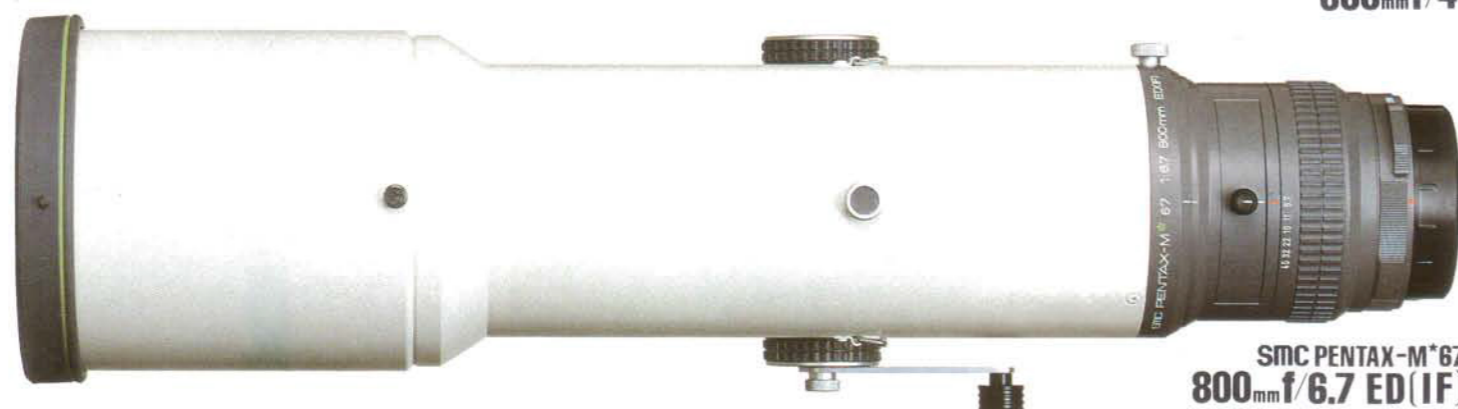

**SMC PENTAX-M* 67
800mm f/6.7 ED(IF)**



**REAR CONVERTER
T5-1.4X**



**SMC REFLEX TAKUMAR 6/7
1000mm f/8**

CHOOSE THE INTERCHANGEABLE LENS TO SUIT YOUR VISION. DIFFERENT PERSPECTIVES WILL ENLARGE YOUR PHOTOGRAPHIC OPTIONS.

180-Degree Angle of View — Fish-Eye 35mm f/4.5

This lens has an overall angle of view of 180°, even wider than the eye's peripheral vision. The fish-eye lens was originally designed for special studies requiring a bird's eye view. The fish-eye lens can encompass the entire horizon in a single picture. Today, photographers find it useful for photographing a complete view of an environment.



Macrophoto Lens — Macro 135mm f/4

This is an essential tool for close-up and macrophoto work. Its focal length is slightly longer than a standard lens. This allows the photographer enough working distance to get close to his subject without disturbing it, an important factor when photographing insects and small animals. The focal length allows ample space for auxiliary lighting without casting a shadow on the subject.



Ultra-Wide-Angle — 45mm f/4

The extreme wide angle lens offers several advantages. It has been well corrected for aberrations to virtually eliminate edge distortion. It creates a natural look along with ultra-wide-angle coverage. This lens corresponds to a 20mm ~ 24mm lens in the 35mm format, and has excellent depth of field. It's the ideal lens for panoramic scenes and indoor photography.



Built-In Leaf-Shutter Lens — 90mm f/2.8

The SMC Takumar 6x7 90mm f/2.8 leaf shutter lens works as a normal lens without cocking the built-in leaf shutter, and has other applications when the leaf shutter is used, including high speed flash synchronization up to 1/500th second. It also makes multiple exposures easily as you simply lock the camera shutter open and trip the lens shutter as often as desired.



Compact Versatile Telephoto — 200mm f/4

This is the ideal lens for portraits. Its compact and bright image field makes it one of the favorite choices of photographers because of its flattering effect on the model. Landscape is another favorite subject among users of this lens. Here, the telephoto lens narrows the angle of view to a specific area, emphasizing graphic design. For the photographer of fine art, this lens is essential.



Double Your Focal Length — Rear Converter T6-2X

Simply fit this quality telephoto adaptor unit between the lens and the camera body mount and the focal length of the lens doubles. The T6-2X adaptor unit is suitable for use with all lenses from 135mm ~ 800mm (except for the 500mm lens). When used with automatic diaphragm lenses, it maintains open aperture metering and other automatic diaphragm features.



Compact Telephoto — Reflex 1000mm f/8

This lens offers the most dramatic effect of the telephoto lenses. The shallow depth of field isolates its subjects from the surrounding environment, producing a clear, easy to see image. The 1000mm reflex lens is extremely compact and light for its powerful focal length. It weighs only 6.6% more than the 600mm telephoto lens, yet offers 66% greater magnification.



View Camera Versatility — 75mm f/4.5 Shift Lens

Useful for photographing architecture and other subjects where converging lines are a problem. The 75mm f/4.5 shift lens features a 360-degree lens barrel rotation and a maximum shift of 20mm in all directions. This corrects converging lines, and lets you correct or not correct distortion for the most dramatic effects. Simply shift the lens horizontally to shoot around obstacles.

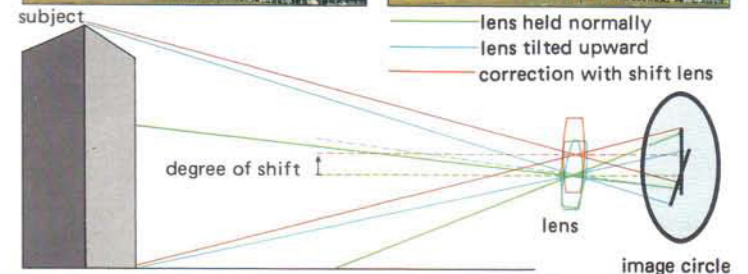

Type	Fish-Eye	Ultra-Wide-Angle	Wide Angle	Standard	Medium Telephoto	Telephoto	Ultra Telephoto	Macro	Shift									
Lens Type	SMC Fish-Eye Takumar 6x7 35mm f/4.5	SMC Pentax 6x7 45mm f/4	SMC Pentax 6x7 55mm f/4	SMC Takumar 6x7 75mm f/4.5	SMC Takumar 6x7 90mm f/2.8	SMC Pentax 6x7 90mm f/2.8	SMC Takumar 6x7 105mm f/2.4	SMC Pentax 6x7 165mm f/2.8	SMC Takumar 6x7 200mm f/4	SMC Takumar 6x7 300mm f/4	SMC Takumar 6x7 400mm f/4	SMC Pentax 6x7 500mm f/5.6	SMC Takumar 6x7 600mm f/4	SMC Takumar 6x7 800mm f/4	SMC Pentax-M* 6x7 800mm f/6.7 ED [IF]	SMC Reflex-Takumar 6x7 1000mm f/8	SMC Macro-Takumar 6x7 135mm f/4	SMC Pentax Shift 6x7 75mm f/4.5
Angle of View	180°	88°	77°	61°	53°	52°	45°	30°	26°	17°	12°	10°	8°	6°	6.4°	5°	36°	61°
Construction (Groups-Elements)	7-11	8-9	8-9	4-5	5-6	5-7	5-6	5-6	4-4	5-5	5-5	4-4	5-6	6-6	8-9	4-6	3-5	8-9
Diaphragm	FA	FA	FA	FA	FA	FA	FA	FA	FA	FA	M	FA	M	M	FA	●	FA	M
Filter Size	☉	82mm	77mm	82mm	67mm	67mm	67mm	67mm	67mm	82mm	77mm	95mm	77mm	77mm	67mm	*	67mm	82mm
Minimum Aperture	f/22	f/22	f/22	f/22	f/22	f/22	f/22	f/22	f/22	f/45	f/45	f/45	f/45	f/45	f/45	—	f/32	f/32
Minimum Focus	0.45m	0.37m	0.40m	0.70m	0.85m	0.65m	1.00m	1.60m	2.50m	5.00m	8.00m	8.00m	12.00m	20.00m	8.00m	35.00m	0.75m	0.70m
Size (dia. x length)	102x73mm	91.5x57.5mm	91.5x75.5mm	91.5x81mm	91.5x63mm	91.5x49mm	91.5x60mm	91.5x98.5mm	91.5x120mm	93x186mm	115x287mm	106.5x398mm	170x370mm	236x611mm	150 x 565mm	180x352mm	91.5x95mm	97x106.5mm
Weight	920g	485g	615g	600g	610g	485g	628g	835g	900g	1,425g	2,570g	3,200g	6,000g	17,700g	6,500g	6,660g	645g	950g

☉—Built-in Lens shutter ●—UV, Y2, O2 & R2 filters built-in ●—Controlled by ND filters *—Skylight, Y2, R2 & ND filters built-in FA—Fully Automatic

M—Manual "Length" does not include mount portion.

ENHANCE YOUR EXPRESSIVENESS WITH THESE 6x7 ACCESSORIES

● **Auto Extension Tube Set** This set of three extension tubes mounts singly or in combination with lenses from 55mm wide-angle to 300mm telephoto. Fully automatic diaphragm action is retained and magnification with all three units and SMC Takumar 6x7 105mm f/2.4 is greater than life-size.



● **Extension Tube Set** A two-piece extension tube set for separate or joint use with the Pentax 6x7 to shorten the minimum focusing distance of ultra telephoto lenses from 400mm to 1000mm (excluding 500mm and M* 800mm).



● **Helicoid Extension Tube** This unit, which is used on the inner bayonet mount of the 6x7, permits continuously variable magnification for lenses from 55mm to 200mm. The tube is equivalent to the No. 2 Auto Extension Tube at minimum extension, and to the No. 3 Tube at maximum extension. When a tube is used in combination with the 105mm standard lens, the subject can be magnified from 0.3X ~ 0.6X, enough to fill the frame with a large-size pack of cigarettes.



● **Right-Angle Finder** Provides corrected image with standard pentaprism and TTL pentaprism for low angle photography.

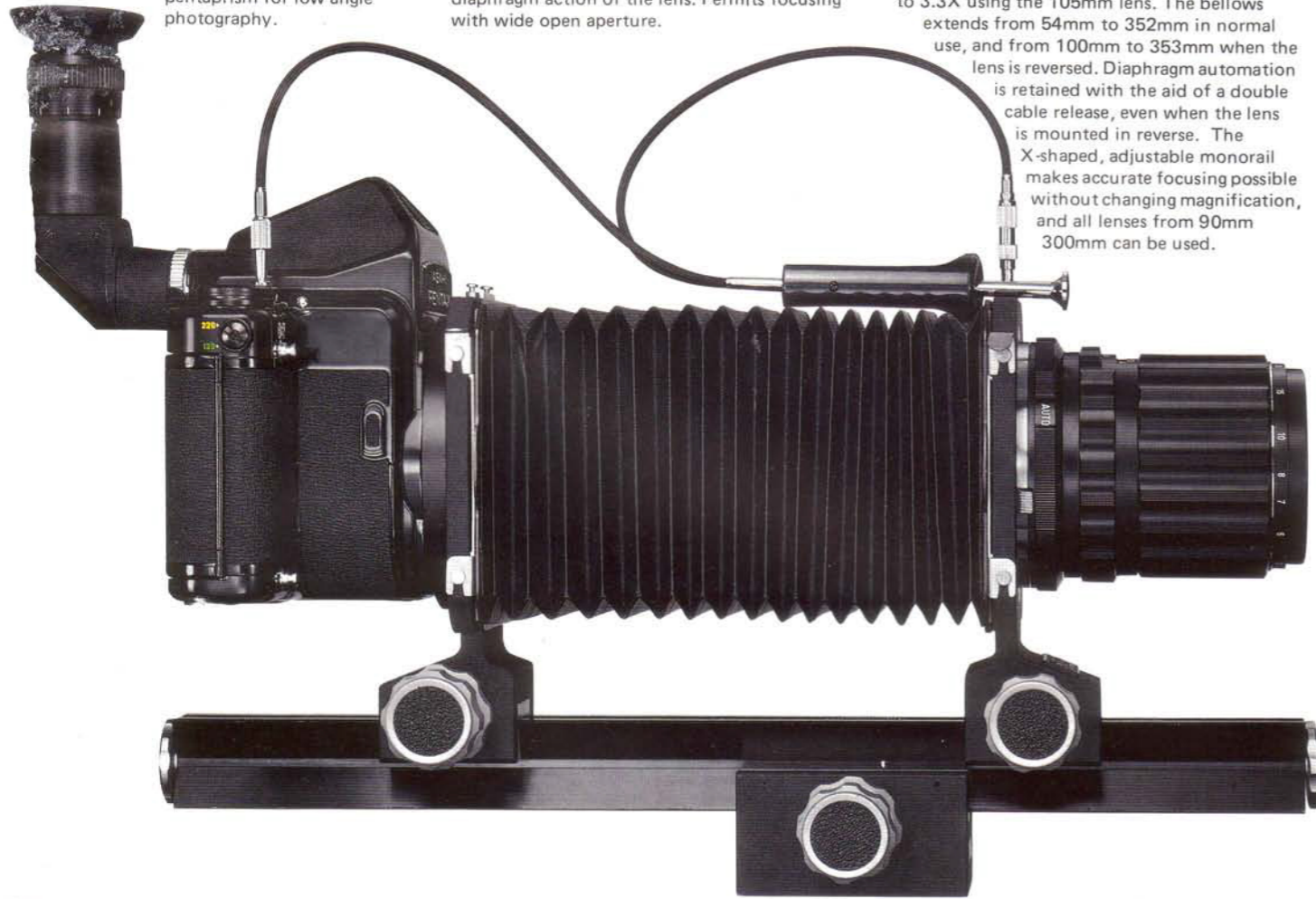

● **Double Release II** Used with the auto-bellows, this unit maintains the automatic diaphragm action of the lens. Permits focusing with wide open aperture.

● **Auto Bellows** The Auto Bellows offers a wide range of magnification ranging from 0.5X to 3.3X using the 105mm lens. The bellows extends from 54mm to 352mm in normal use, and from 100mm to 353mm when the lens is reversed. Diaphragm automation is retained with the aid of a double cable release, even when the lens is mounted in reverse. The X-shaped, adjustable monorail makes accurate focusing possible without changing magnification, and all lenses from 90mm - 300mm can be used.

● **SMC Close-up Lenses** These close-up lenses are lightweight and extremely convenient for close-up work. They easily mount by screwing into the filter threads of the lens, and they can also be used jointly with most Pentax filters. These close-up lenses are available in three filter size.



● **Reverse Adapter** These adapters make it possible to mount lenses in reverse on the Helicoid Extension Tube. The 49mm filter size adapts 35mm SLR lenses and the 67mm adapts for 6x7 lenses.



● **Slide Holder K** An extremely handy slide holder unit for copying 35mm mounted transparencies on the 6x7 format. Used in conjunction with the 49mm reverse adapter, 35mm format 50mm macro lens and Helicoid Extension Tube, it offers magnification up to 2X.



● **Eyecup** The rubber Eyecup attaches to the eyepiece of the pentaprism and right angle finders to prevent extraneous light from entering into the viewfinder.



● **Correction Lenses** These attach to the eyepiece of the pentaprism finders to correct for near and farsightedness. Several diopters are available from +2 ~ -5D.



● **Quick Focusing Ring** With the quick focusing rings in place, it is possible to focus the lens rapidly and easily. Quick focusing rings are available in 2 types: A-type for use with lenses from 105mm to 200mm and B-type for lenses from 35mm ~ 90mm.



● **Grip:** Designed to facilitate handling and quick shooting with the 6x7. The grip fixes in place with a screw and attaches to the universal lugs on the left side of the camera body. The strap may be reattached to the right hand lugs for vertical carrying when using the grip. A shoe is provided on top of the grip for flash and other accessories.



● **Cable Release 30**

● **Cable Release 50**



● **Remote Battery Cord** When batteries are used at below freezing temperatures, their voltage may drop, causing the electronic shutter to malfunction. The Remote Battery Cord can eliminate this problem by placing the battery chamber into a warm pocket and plugging the cord into the camera.



● **Slide Copier** This unit works in conjunction with the Auto Bellows unit to make copies of the 6x7 or 35mm slides, whether mounted or unmounted. Magnification can be varied to crop sections of the original picture.



● **Magnifier** This magnifier has a built-in diopter adjustment for optimum viewing comfort and magnifies the central area of the focusing screen by 2X for critical focusing.



● **K-Mount Adapter** The K-Mount Adapter is available for using 6x7 lenses on 35mm SLR's. It can be used on inner and outer bayonets with stopped down metering.



● **Copy Stand** This deluxe copy stand has double posts for rigid support of the Pentax 6x7 and can copy an area of 14x20 inches and smaller. When the bellows and extension tubes are attached to the camera, the copy stand offers convenience and flexibility for copywork and macrophotography.

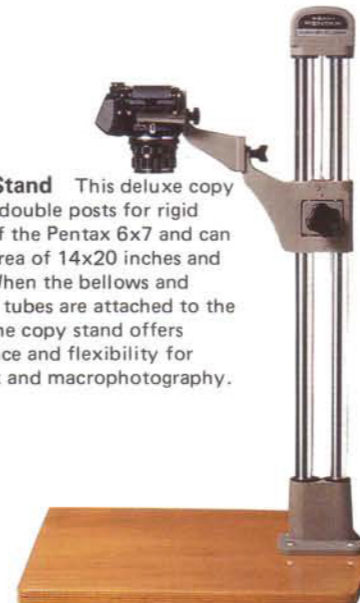

● **6x7 Professional Trunk Case II** A durable professional-type trunk case offering maximum protection.



● **Shoulder Strap** A durable carrying strap with metal fasteners that attach to the universal lugs of the camera. Four lugs permit optional horizontal and vertical carrying; two straps may be used for added security in mountain climbing, etc.



● **Lens Cases/Soft Lens Case** In addition to the standard-type hard cases, a pouch-type soft case is available for lenses from 35mm - 200mm. It is convenient for carrying two or more lenses in a camera bag.



● **Carrying Case** A professional looking, compact case which will hold a camera with standard lens, some accessories, and film. Designed for easy use.



FOR PRECISE EXPOSURES

● Standard Filters and SMC Filters

There are several filters available which can enhance black and white and color photography. There are four filters for black & white including UV for lens protection, Y2 to improve natural tones, O2 for better contrast, and R2 for infrared film. These filters change the subject contrast and can therefore aid in picture composition. There are also specially made filters for color film, including the Skylight filter, Cloudy filter, and Morning and Evening filter. Filters are available in 67mm, 77mm, 82mm, 95mm and 100mm sizes.



● Polarizing Filter

This is an important filter for color photography because it eliminates glare and enriches colors. It minimizes reflections on glass, and wet surfaces like a rainy street and deepens the blue in the sky to enhance clouds and nature pictures.



● Gelatin Filter Frames

The filter frame holder is available in three sizes- 67mm, 82mm and 100mm. All accept the standard 3x3 inch gelatin filter squares and allow the use of two filters at a time.



● Lens-Hoods

Various square-type lens-hoods are available for lenses without built in hoods. The clip-on lens-hoods are for the 45mm and 55mm lenses; the hood for the 75mm lens (also macro 135mm lens) comes in two bayonet sections. The hoods for the 90mm and 105mm lenses are screw-in types.



- 67mm lens cap
- Lens mount cap (inner bayonet)
- Lens mount cap (outer bayonet)
- Body mount cap
- Pentaprism cap
- Finder cap
- Lens strap

● Digital Spotmeter

Large, bright red LED's illuminate the viewfinder of the handy compact and lightweight digital spotmeter model, which measures an acute 1-degree area of the subject for precise exposure measurements. The LEDs offer maximum visibility regardless of prevailing lighting conditions. Correct exposure is immediately displayed in EV numbers (rounded off to the nearest 1/3 EV). The entire EV range is 1 to 20 with ASA 100 film; weight: 245g.

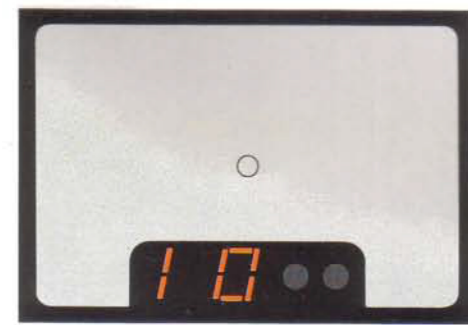

When the exposure value is from 9-5/6 to 10-1/6EV, the meter display reads "10".

When the exposure is between 10-1/6 and 10-1/2, the meter displays one dot by "10" to indicate 10-1/3.

When the exposure value is between 10-1/2 and 10-2/3, two dots light by the "10" to indicate 10-2/3.

When the exposure value is between 10-1/2 and 10-2/3, two dots light by the "10" to indicate 10-2/3.

When the brightness of the scene exceeds 19-2/3, the value "0" is displayed.

● Spotmeter V

This precision instrument allows for exposure measurement of an acute angle of just 1 degree, enabling exact readings of main subjects and areas of the picture of prime interest. In addition, use of a virtually instantaneous response Silicon Photo Diode ensures the utmost precision of exposure readouts. The viewfinder features a scale and pointer with readings given in EV numbers, over an EV range of 1 to 19 with ASA 100 film. Model V-FL is similar to Model V, except that exposure information is given in foot lamberts, making it especially valuable for TV and film metering. Model V-FL also calculates illuminance ratios.



There are various methods for reading a spot meter such as averaging the maximum and minimum light values of the subject, or averaging medium tone area. The shadow method measures only the lowest light, and the highlight method gives priority to the highlights.

● Light Sensitivity Graph of SPD sensor

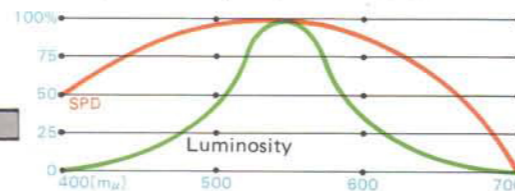

THE PENTAX 6x7 SYSTEM HAS THE ANSWERS TO YOUR MOST DIFFICULT PROBLEMS.

Pentax 6x7 System

● 6x7 Standard Set
6x7 Body with Mirror-Up Device
SMC Pentax 6x7 90mm f/2.8
Pentaprism Finder

● 6x7 Body with Mirror-Up Device

Interchangeable Lenses

- SMC Fish-Eye Takumar 6x7 35mm f/4.5 (Built-in filters)
- SMC Pentax 6x7 45mm f/4 (82mm)
- SMC Pentax 6x7 55mm f/4 (77mm)
- SMC Takumar 6x7 75mm f/4.5 (82mm)
- SMC Takumar 6x7 90mm f/2.8 (67mm) (Built-in lens shutter)
- SMC Pentax 6x7 90mm f/2.8 (67mm)
- SMC Takumar 6x7 105mm f/2.4 (67mm)
- SMC Pentax 6x7 165mm f/2.8 (67mm)
- SMC Takumar 6x7 200mm f/4 (67mm)
- SMC Takumar 6x7 300mm f/4 (82mm)
- SMC Takumar 6x7 400mm f/4 (77mm)
- SMC Pentax 6x7 500mm f/5.6 (95mm)
- SMC Takumar 6x7 600mm f/4 (77mm)
- SMC Takumar 6x7 800mm f/4 (77mm)
- SMC PENTAX-M* 67 800mm f/6.7 ED (IF) (67mm)

- Rear Converter T5-1.4X
- SMC Reflex-Takumar 6x7 1000mm f/8 (Built-in filters)
- SMC Macro-Takumar 6x7 135mm f/4 (67mm)
- SMC Pentax Shift 6x7 75mm f/4.5 (82mm)
- 6x7 Rear Converter T6-2X

Relative Accessories to Finder

- Pentaprism Finder
- TTL Pentaprism Finder
- Rigid Magnifying Hood
- Folding Focusing Hood

- Focusing Screens
- Matte + Central Microprism Spot
- Matte + Central Split-Image Spot
- Matte + Crossline Field
- Matte + Crossline Field + Central Microprism Spot

- All Matte Field
- Magnifier
- Correction Lenses (-5~+2DPT)
- Eyecup
- Eyepiece Ring
- Right-Angle Finder

Copying & Close-Up Accessories

- Auto Bellows Set
- Slide Copier
- Auto Extension Tube Set
- Extension Tube Set
- Helicoid Extension Tube
- Slide Holder K
- Cable Release 30
- Cable Release 50
- Reverse Adaptor (49mm) (67mm)
- 6x7 SMC Close-Up Lenses 67mm (S82-T132-T226)
- Copy Stand

Filters & General Accessories

- SMC Filters 67mm 77mm 82mm 95mm 100mm
- Standard Filters 67mm 77mm 82mm 100mm
- Polarizing Filter 67mm
- Gelatin Filter Frames (67mm) (82mm) (100mm)
- Lens-hood for 45mm Lens
- Lens-hood for 55mm Lens
- Lens-hood for 75mm Lens
- Lens-hood for Standard Lens
- 67mm Lens Cap
- Rear Lens Cap
- Body Cap
- Grip
- AF400T Bracket
- Remote Battery Cord
- Quick Focus Ring A, B
- Camera Strap

Cases

- 6x7 Trunk Case Professional II
- Lens Soft Case
- Lens Case for Standard Lenses
- Carrying Case

Exposure Meters

● Spotmeter V

● Digital Spotmeter

18

19

PENTAX

6x7

Ideal Format SLR Camera – The Professional's Choice

